

Users manual



Ht40B PID controller

Ht40B, 01/03, soft 4.11/rev. 1 english

HTH8 s.r.o.

Eimova 880, 572 01 Polička
Czech Republic
tel.: +420 461 619 515
fax: +420 461 619 513

e-mail: info@hth8.cz
www.hth8.cz

1 Important

Ht40B is a temperature / process controller intended for the built-in to panel. The format of controller is 96 x 48 mm (1/8 DIN).

The scope of the controller:

- controlling of stp value,
- controlling Master – Slave (1 controller is supervisory MASTER, the others are SLAVEs – receive stp value),
- cascade controlling (it is used in systems with long lag times).

The controller can be equipped with 1 input:

- temperature (thermocouples + rtd sensor -Pt100),
- process (0-20mA, 4-20mA, 0-5V, 1-5V, 0-10V),

3 outputs:

- control (heating control),
- auxiliary (cooling control, signalling),
- alarm,

and communication lines:

- RS-232, protocol MODBUS RTU,
- EIA-485, protocol MODBUS RTU.

The controller is easy to run and operate. The parameters set can be locked and thus preventing from deleting by a user.

User manual for the controller Ht40B is divided into the particular chapters. When you install and put it into operation we recommend proceeding in the following way:

If you are a final user, the controller is in the default setting by the supplier

If you are a final user, you will get the device in the customized setting and you can view and change only the parameters that you need for your own work on the controller.

If you are a new user of the device, focus on the following chapters:

- [Basic terms](#), here it is explained the key functions, displays, and so on....
- [Basic mode](#), the description of basic mode of controller.
- [User level](#), in this chapter you will find the information on the parameters accessible for a user and the information on the basic features of the controller.

If you are carrying out the complete installation and setting of the controller

In this case you proceed in accordance with the following chapters:

- [Installation](#), in this chapter it is described how to build in a controller into panel.
- [Principals of installation](#), we recommend you to observe the guidelines described in this chapter.
- [Wiring](#), the description for wiring of the controller.
- [Putting into operation](#), at first power-up you enter the initial menu in which you can configure and set the most important parameters of controller.

According to the procedure you will perform installation, wiring and basic setting of controller. You can find out more details on the scope of the controller and its operation in the following chapters.

For the users who have the controller completely set, we recommend to perform the setting of all the parameters in *service level*, menu **ConF**. **Initial password** for the entry to service level is set to **995**.

2 Basic terms

To avoid problems in operation of device the user should be able to manage its operation, setting parameters, ...

2.1 Operation and description of controller



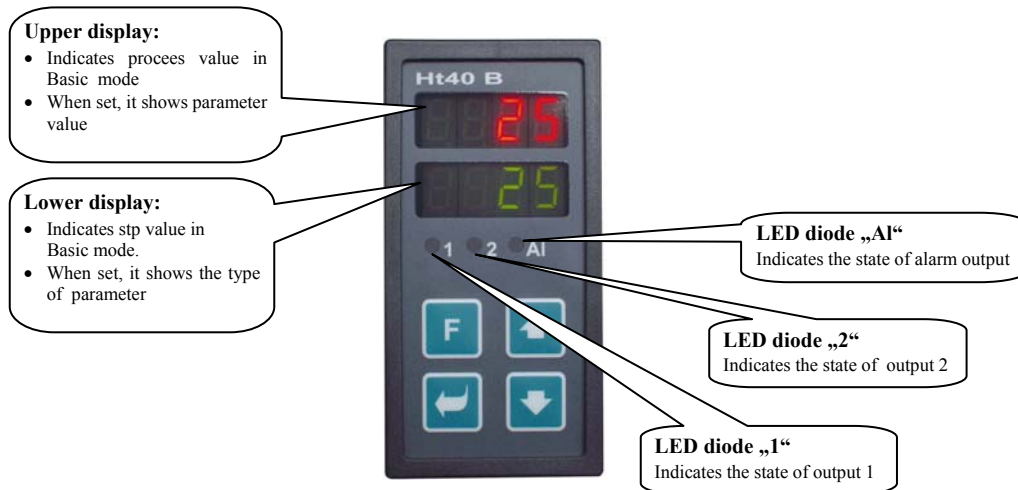

On the front panel board you can see 2 displays, 3 control lights (LED diodes) for indicating a status of outputs. The device is set and configured via 4 key-buttons.

Function of indicators



Function of key-buttons

The setting of parameters of the controller is performed via key-board. The function of each key-button is as follows:

-  key for setting and viewing of parameters of user, operation, configuration and user level. By pressing this key **you confirm the change in configured parameter** and the controller comes to another parameter.
-  key for decreasing a value of parameter. The value of parameter is either the figure or abbreviation composed of maximum 4 letters.
-  key for increasing a value of parameter.
-  key for switching between automatic and manual operation, see page [8](#).

2.2 Information and error messages















Information and error messages are indicated only in *basic mode*, see page [5](#).

Information messages, upper display

-  ... error of input sensor or input is not set.

Information messages, lower display

Information messages on lower display blink, they can be:

-  ... the controller is in manual operation, the output power is set by a user.
-  ... indication of ramp function.
-  ... indication of cascade controlling.
-  ... starting autotuning of PID set 1 of the output 1,   .
-  ... starting autotuning of PID set 2 of the output 1,   .
-  ... starting autotuning of PID set of the output 2,   .

Error messages, lower display

If there is a error message indicated then the control outputs are switched OFF, the signal output is switched OFF, the alarm output is activated.

- **Err0** ... error in FLASH memory of program. Switch the controller OFF and ON again. If the problem persists, contact your supplier.
- **Err1** ... error in EEPROM memory for configuration and operation parameters. The troubleshooting error can be made by restarting of all parameters in *service level*. After restart it is necessary to set up all parameters again. This can be done only by an experienced user. If the trouble persists, contact your supplier.
- **Err3** ... error in A/D converter. It can be caused by electrical impulse at input, too low temperature and excessive humidity, Switch the controller OFF and ON again. If the problem persists, contact your supplier.

2.3 Overview of levels, menus

For the right function of the controller it is necessary to set up its parameters properly. For better understanding the parameters are sorted out to groups (levels and menus). Level is superior to menu, menu is a part of level (menu **out1**). The structure of sorting shows the following picture.

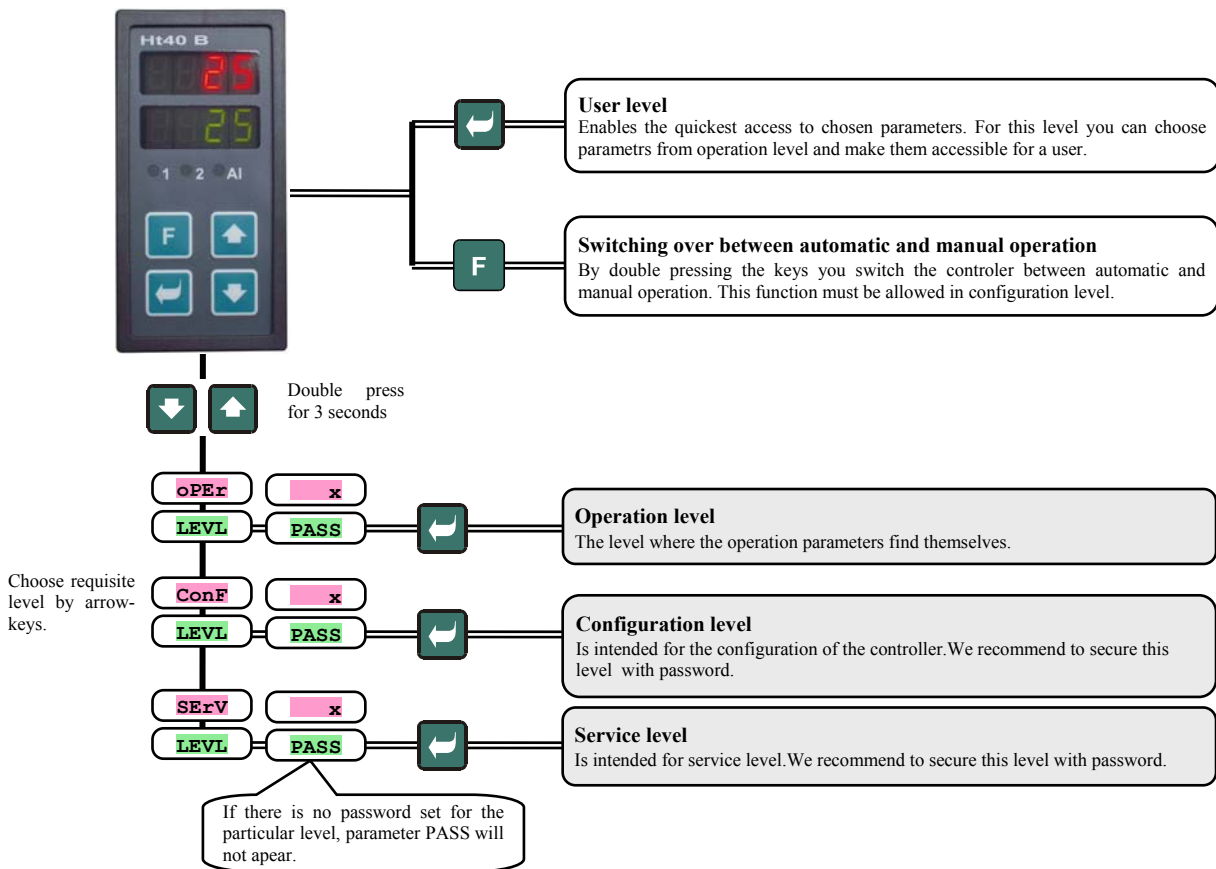

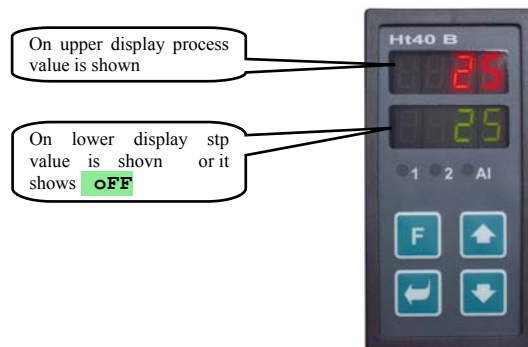

3 Basic mode

The controller is in **Basic mode** when powered up (the initial set-up must be performed, see page 27). On upper display process value is shown, on lower display there can be stp value or heading **OFF** (at Master / Slave controlling, if the controller does not receive stp value).



- When **controlling to stp value** there is stp value shown on lower display.
- When in **Master / Slave controlling** (the controller is Slave) there is stp value shown on lower display. If the controller does not receive stp value and switching OFF is set for the output, on lower display heading **OFF** is lit and the control output is switched OFF.
- When in **cascade controlling** there is calculated stp value shown on lower display and heading **csca** blinks.
- When in **manual operation** there is output power in % shown on lower display and heading **Man** blinks.
- If there is any other heading on lower display, the controller **is not in basic mode**, parameters are set or viewed.
- Information and error messages are indicated only in **basic mode**.



Return to basic mode

- To return to **basic mode** press shortly the keys  .
- If there is no key pressed for 60 seconds, the controller itself returns to **basic mode**.

4 User level

User level is intended for the quick access to the most common parameters for a user.

To enter user level and to go through this level press the key .

To return from user level you must go through all the parameters or by pressing shortly the keys  .

You can configure freely the structure of user level:

- you can define which parameters and menus will be in user level,
- you can define on which position these parameters(menus) will be placed,
- the parameters and menus are displayed only in case that their showing has the meaning (e.g. the parameters of controlling are shown only in case that output is set as the control output).

Overview of all the parameters and menus of user level

Display	Procedure
PCn1	Indicates the power in % of the control output 1. It is displayed only then if the output 1 is set as the control output.
PCn2	Indicates the power in % of the control output 2. It is displayed only then if the output 2 is set as the control output.
AoFF	Menu for switching OFF of permanent alarm. Set YES and confirm to switch OFF the permanent alarm.
Aut	Starting / ending of autotuning/automatic setting of PID parameters: <ul style="list-style-type: none"> • oFF, autotuning /automatic setting of PID parameters is turned OFF. • ht, starting of autotuning/automatic setting of PID parameters for heating • CL, starting of autotuning/automatic setting of PID parameters for cooling.
L-r	Selection for setting of stp value: <ul style="list-style-type: none"> • L, stp value is local (it is set in the controller). • M-S, remote setting of stp value via communication line, it is used for system <i>Master-Slave</i>. • CSCD, remote setting of stp value via communication line, it is used for <i>cascade controlling</i>.
dIF	Difference of remote stp value for system <i>Master-Slave</i> . Range: -499 to 499 °C.
CdLo	Low limit range of remote setting stp value for <i>cascade controlling</i> . Range: -499 to CdhI °C.
CdhI	High limit range of remote setting stp value for <i>cascade controlling</i> . Range: CdLo to 2499 °C.
Pb1A	Proportional band of the output 1, the first set of PID parameters. Range: 1 to 2499 °C.
It1A	Integral value of the output 1, the first set of PID parameters. Range: oFF , 0.1 to 99.9 minutes.
dE1A	Derivative value of the output 1, the first set of PID parameters. Range: oFF , 0.01 to 9.99 minutes.
Pb1b	Proportional band, the second set of PID parameters. Range: 1 to 2499 °C.
It1b	Integral value, the second set of PID parameters. Range: oFF , 0.1 to 99.9 minutes.
dE1b	Derivative value, the second set of PID parameters. Range: oFF , 0.01 to 9.99 minutes.
hYS1	Hysteresis of the output 1, this single parameter is set only for ON/OFF control. Range: 1 to 249 °C.
Pb2A	Proportional band of the output 2. Range: 1 to 2499 °C.
It2A	Integral value of the output 2. Range: oFF , 0.1 to 99.9 minutes.
dE2A	Derivative value of the output 2. Range: oFF , 0.01 to 9.99 minutes.
hYS2	Hysteresis of the output 2, this single parameter is set only for ON/OFF control. Range: 1 to 249 °C.
o2Lo	Low limit of signalling. Output is activated when process value is <i>lower</i> than the set signalling limit. Range: <ul style="list-style-type: none"> • -499 to o2hI °C for ot2 = SGPr. • -999 to 0 °C for ot2 = SGdE.
o2hI	High limit of signalling. Output is activated when process value is <i>higher</i> than the set signalling limit. Range: <ul style="list-style-type: none"> • o2Lo to 2499 °C for ot2 = SGPr. • 0 to 999 °C for ot2 = SGdE.

ALLo	<p>Low limit of alarm. Alarm is activated when process value is <i>lower</i> than the set alarm limit.</p> <p>Range:</p> <ul style="list-style-type: none"> -499 to ALhI °C for ot3 = ALPr. -999 to 0 °C for ot3 = ALdE.
ALhI	<p>High limit of alarm. Alarm is activated when process value is <i>higher</i> than the set alarm limit.</p> <p>Range:</p> <ul style="list-style-type: none"> ALLo to 2499 °C for ot3 = ALPr. 0 to 999 °C for ot3 = ALdE.

Setting of parameters and menus in user level

User level provides a user with the quickest access for viewing and setting of parameters. The list of the parameters that will be present and accessible for a user in user level, as well as their sequence, can be freely configured. You will carry out the formation of user level in *configuration level*, menu **uSEr**.

Example how to create user menu:

You want to place on the 1st position in *user level* the parameter for starting autotuning **Aut**, on the 2nd high limit of alarm **ALhI**. Proceed as follows:

- Set the parameter **StP1** = **Aut**.
- Set the parameter **StP2** = **ALhI**.
- 3rd to 8th positions are not used, for parameters **StP3** to **StP8** set **no**.

You can view the result in *user level*

4.1 Controlling of stp value

When the controller maintains stp value, lower display shows stp value and upper display shows process value. Setting of stp value can be changed with the arrow-keys, the new stp value is edited after approx. 2 seconds from the last pressing of the key.

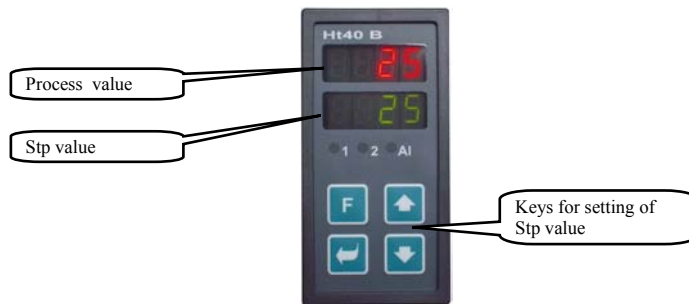

Ramp function

When the controller is powered up, rapid temperature changes appear. If this rapid increase in temperature is not wanted, you can control the ramp rate to stp value with the ramp function.

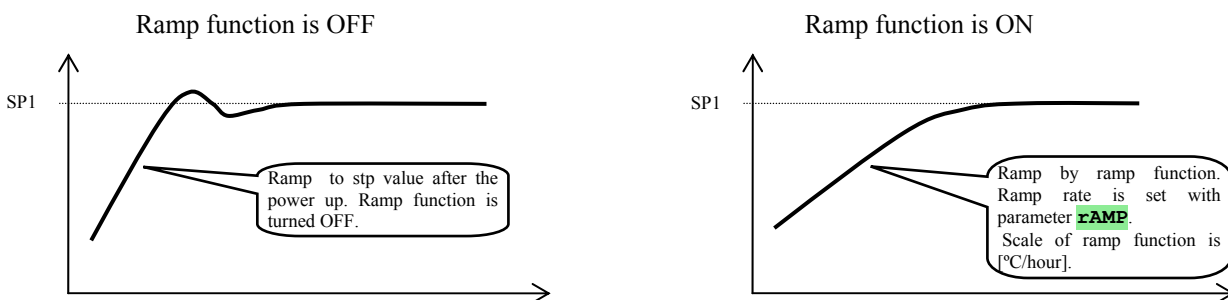

- Ramp function ensures the reaching stp value SP1 in the linear way.
- Ramp function is active only after the controller is turned on and it is ended by reaching stp value SP1.
- When ramp function is active, on lower display there is stp value SP1 and blinks **rAMP**.
- Ramp function is set in *configuration level*, menu **sys**, parameter **rAMP** [°C/hour].
- If parameter **rAMP** = **OFF**, ramp function is turned OFF.

4.2 Automatic / manual operation of controller

Automatic operation of controlling requires the closed control loop. The user adjusts stp value and the controller regulates the output power that is supplied to system.

At **manual operation** the user adjusts the required output power.

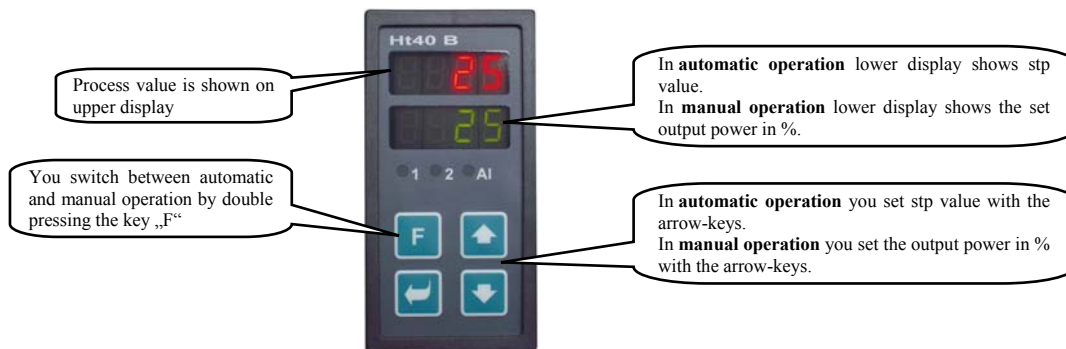

Manual operation

Manual operation is set by double pressing the key **F**. It must be allowed by setting parameter **FKEY** = **A-M**. Parameter **FKEY** is found in *configuration level*, menu **sys**.

Important:

- When in manual operation the controller can not influence the output power that is set by a user. The behavior of the system is then fully under users control.
- When in manual operation, **Man** blinks on lower display.
- The controller remains in the chosen mode of operation even after the power interruption.
- In manual operation the zero output power is set after the power interruption.
- In manual operation the output power is always set in % (0 to 100 for heating, -100 to 0 for cooling, -100 to 100 for heating and cooling) and even in the case that the output is configured as the ON/OFF output.

4.3 Parameters of the control output, PID controlling

The controller Ht40B can be configured for ON/OFF as well as PID controlling and it enables:

- Heating controlling (the output 1).
- Cooling controlling (the output 2).
- Controlling of heating and cooling (the output 1 and 2).

The description of principals of controlling is found on page [16](#).

Heating, ON/OFF controlling

ON/OFF controlling of heating is set with the parameter **ot1** = **ht2**. Parameter **ot1** is found in *configuration level*, menu **out1**.

In *operation level* you set hysteresis of ON/OFF controlling, parameter **hys1**.

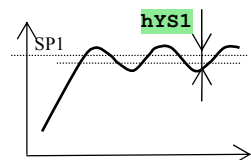

Heating, PID controlling

PID controlling of heating is set with parameter **ot1** = **ht**. Parameter **ot1** is found in *configuration level*, menu **out1**.

In *operation level* you set PID parameters:

- **Pb1A**, **It1A**, **dE1A**, If only 1 set of PID parameters is used (parameter **ALGo**).
- **Pb1A**, **It1A**, **dE1A**, **Pb1b**, **It1b**, **dE1b**, if both sets of PID parameters are used.

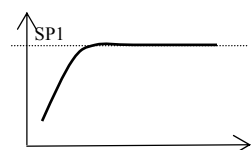

Cooling, ON/OFF controlling

ON/OFF controlling of cooling is set with the parameter $ot2 = CL2$. Parameter $ot2$ is found in *configuration level*, menu $out2$. STP value for cooling is put down by the value set with parameter $SP2$, that is found in *configuration level*, menu $out2$. In *operation level* you set hysteresis of ON/OFF controlling, parameter $hYS2$.

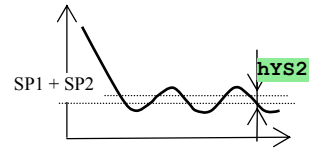

Cooling, PID controlling

PID controlling of cooling is set with parameter $ot2 = CL$. Parameter $ot2$ is found in *configuration level*, menu $out2$. STP value for cooling is put down by the value set with parameter $SP2$, that is found in *configuration level*, menu $out2$. In *operation level* you set PID parameters:

- $Pb2A$, $It2A$, $dE2A$, PID parameters defines the response of the controller.

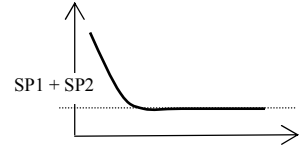

4.4 Autotuning – automatic setting of PID parameters

The controller is fitted with the function that sets automatically PID parameters.

Autotuning of PID parameters can be started only when the controller maintains stp value $SP1$ (parameter $L-r = I$)

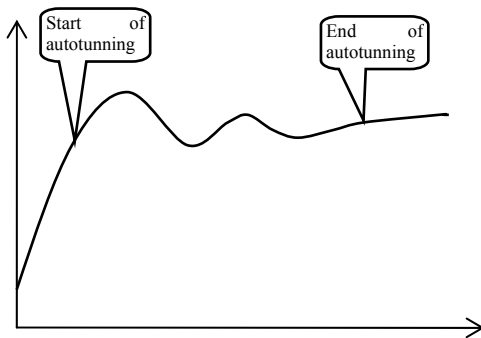

When in autotuning, on lower there are the following headings blinking:

- $Aut1$... the controller adjusts parameters $Pb1A$, $It1A$, $dE1A$ for heating.
- $Aut2$... the controller adjusts parameters $Pb1b$, $It1b$, $dE1b$ for heating.
- $Aut3$... the controller adjusts parameters $Pb2A$, $It2A$, $dE2A$ for cooling.

Procedure of starting autotuning:

- Autotuning you can start with parameter $Aut = ht$ (setting parameters for heating) or $Aut = CL$ (setting parameters for cooling). Parameter Aut you will find in *operation level*. The control output must be set for PID controlling.
- The controller explores the characteristics of system from switching ON/OFF on the output and determines optimal PID parameters. It can cause an overshoot.
- In the course of autotuning on lower display the information messages ($Aut1$, $Aut2$, $Aut3$) blink.
- After the autotuning is finished the parameters are edited and the information messages stop blinking.





Important:

- Parameters $Pb1A$, $It1A$, $dE1A$, are set when 1 set of PID parameters is used ($ALGo = PId$) or the both sets of PID parameters are used ($ALGo = 2PId$) and the actual set point value is lower than parameter $SPId$.
- Parameters $Pb1b$, $It1b$, $dE1b$, are set if the actual set point value is higher than parameter $SPId$ when the both sets of PID parameters are used ($ALGo = 2PId$)

Parameters $ALGo$ and $SPId$ are found in *configuration level*, menu $out1$.

5 Operation level

In operation level you can set parameters which are available to a user.

From basic mode to operation level you will get by pressing the keys   for 3 seconds. On lower display it appears **LEVL**, on upper display set **OPER** and confirm with the key . If **PASS** appears on lower display the level is secured with the password. In this case set the right password with the arrow-keys and confirm with the .

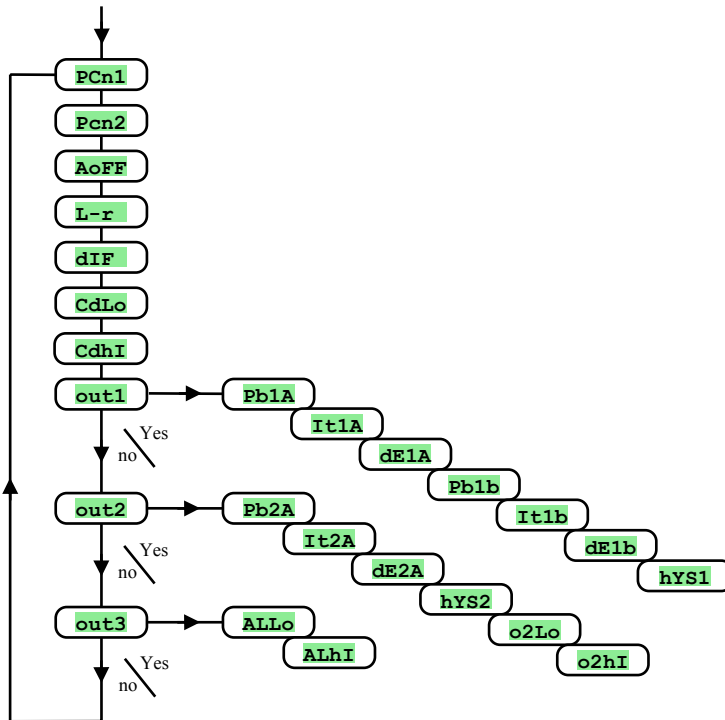

Menu of operation level

Display	Meaning
PCn1	Shows the actual power of the output 1 in %.
PCn2	Shows the actual power of the output 2 in %.
AoFF	You can switch OFF permanent alarm by setting YES and confirming.
Aut	Starting / turning OFF of autotuning of PID parameters: <ul style="list-style-type: none"> oFF, turning OFF of autotuning of PID parameters. ht, starting of autotuning of PID parameters, heating. CL, starting of autotuning of PID parameters, cooling.
L-r	Selection for setting of stp value: <ul style="list-style-type: none"> L, stp value is local (it is set in the controller). M-S, remote setting of stp value via communication line, it is used for system <i>Master-Slave</i>. CSCD, remote setting of stp value via communication line, it is used for <i>cascade controlling</i>.
dIF	Difference of remote stp value for system <i>Master-Slave</i> . Range: -499 to 499 °C.
CdLo	Limit of low range for remote stp value for <i>cascade controlling</i> . Range: -499 to CdhI °C.
CdhI	Limit of high range for remote stp value for <i>cascade controlling</i> . Range: CdLo to 2499 °C.

out1, menu for parameters of the output 1

Menu is intended for manual setting of PID parameters or for fine tuning of parameters when the controlling is not enough precise. To enter this menu set **YES** on upper display and confirm.

Display	Meaning
Pb1A	Proportional band of the output 1 , the first set of PID parameters. Range: 1 to 2499 °C.
It1A	Integral value of the output 1 , the first set of PID parameters. Range: oFF , 0.1 to 99.9 minutes.
dE1A	Derivative value of the output 1 , the first set of PID parameters. Range: oFF , 0.01 to 9.99 minutes.
Pb1b	Proportional band , the second set of PID parameters. Range: 1 to 2499 °C.
It1b	Integral value , the second set of PID parameters. Range: oFF , 0.1 to 99.9 minutes.
dE1b	Derivative value , the second set of PID parameters. Range: oFF , 0.01 to 9.99 minutes.
hYS1	Hysteresis of the output 1 , this single parameter is set only for ON/OFF control. Range: 1 to 249 °C.

The description of PID parameters is found on page [16](#).

out2, menu for parameters of the output 2

In menu the control parameters of the output 2 (**ot2** = **CL** or **ot2** = **CL2**) are shown or the limits of signal output (**ot2** = **SGPr** or **ot2** = **SGdE**). To enter menu set **YES** on upper display and confirm.

Display	Meaning
Pb2A	Proportional band of the output 2 . Range: 1 to 2499 °C.
It2A	Integral value of the output 2 . Range: oFF , 0.1 to 99.9 minutes.
dE2A	Derivative value of the output 2 . Range: oFF , 0.01 to 9.99 minutes.
hYS2	Hysteresis of the output 2 , this single parameter is set only for ON/OFF control. Range: 1 to 249 °C.
o2Lo	Low limit of signalling . Output is activated when process value is <i>lower</i> than the set signalling limit. Range: <ul style="list-style-type: none"> -499 to o2hI °C for ot2 = SGPr. -999 to 0 °C for ot2 = SGdE.
o2hI	High limit of signalling . Output is activated when process value is <i>higher</i> than the set signalling limit. Range: <ul style="list-style-type: none"> o2Lo to 2499 °C for ot2 = SGPr. 0 to 999 °C for ot2 = SGdE.



out3, menu for setting of alarm limits

The menu is shown when the output 3 is set as the alarm one (**ot3** = **ALPr** or **ot3** = **ALdE**). In menu you can choose the limits of alarm.

Display	Meaning
ALLo	Low limit of alarm . Alarm is activated when process value is <i>lower</i> than the set alarm limit. Range: <ul style="list-style-type: none"> -499 to ALhI °C for ot3 = ALPr. -999 to 0 °C for ot3 = ALdE.
ALhI	High limit of alarm . Alarm is activated when process value is <i>higher</i> than the set alarm limit. Range: <ul style="list-style-type: none"> ALLo to 2499 °C for ot3 = ALPr. 0 to 999 °C for ot3 = ALdE.

6 Configuration level

Configuration level is intended for the basic setting of the controller. In this level **the control output is turned OFF** and **alarm and signal outputs are deactivated**.

To enter configuration level from basic mode press both the keys   for 3 seconds. On lower display it appears **LEVL**, on upper display set via the arrow-keys **ConF** and confirm. If **PASS** appears on lower display, configuration level is secured with the password. In this case set the password via the arrow-keys and confirm again .

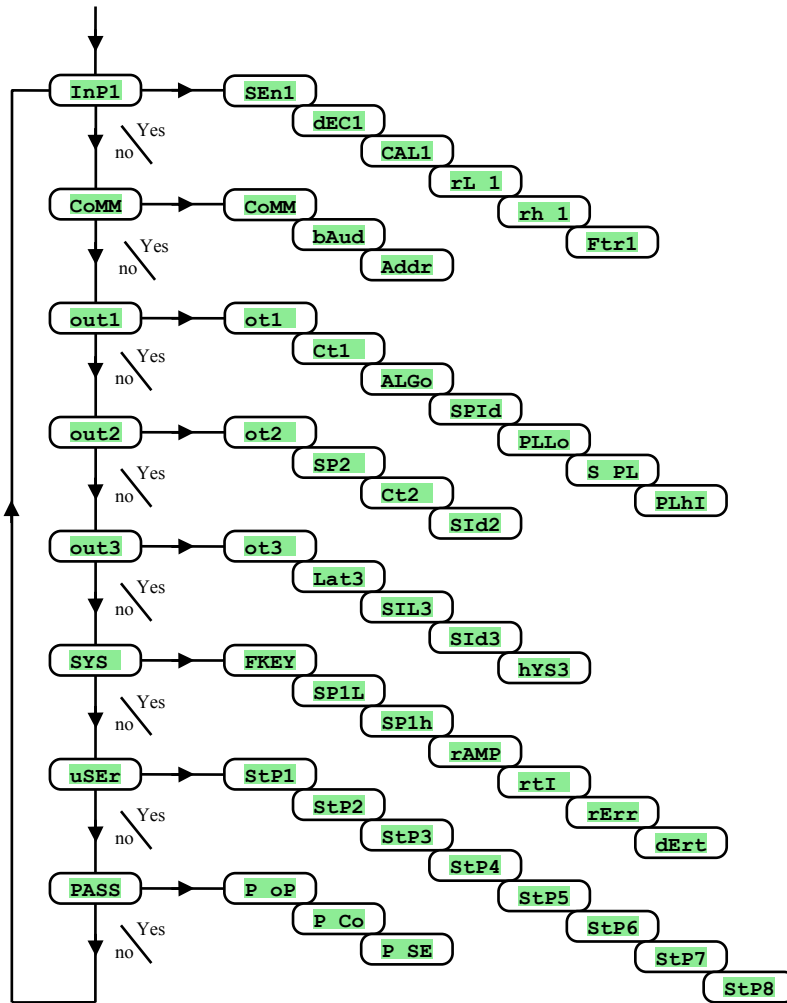

InP1, input setting

Display	Meaning
SEn1	<p>Setting of input sensor – thermal input.</p> <ul style="list-style-type: none"> no ... input is not set. J ... thermocouple J, range -200 to 900°C. K ... thermocouple K, range -200 to 1360°C. t ... thermocouple T, range -200 to 400°C. n ... thermocouple N, range -200 to 1300°C. E ... thermocouple E, range -200 to 700°C. r ... thermocouple R, range 0 to 1760°C. S ... thermocouple S, range 0 to 1760°C. b ... thermocouple B, range 300 to 1820°C. C ... thermocouple C, range 0 to 2320°C. d ... thermocouple D, range 0 to 2320°C. rtd ... rtd sensor (Pt100), range -200 to 800°C. <p>Setting of input sensor ... process input:</p> <ul style="list-style-type: none"> no ... input is not set. 0-20 ... 0 – 20 mA, range -499 to 2499 units. 4-20 ... 4 – 20 mA, range -499 to 2499 units. 0-5 ... 0 – 5 V, range -499 to 2499 units. 1-5 ... 1 – 5 V, range -499 to 2499 units. 0-10 ... 0 – 10 V, range -499 to 2499 units.
dEC1	<p>Setting of decimal point for displaying – thermal input.</p> <ul style="list-style-type: none"> 0 ... no decimal point. 0.0 ... 1 decimal point. <p>Setting of decimal point for displaying – process input:</p> <ul style="list-style-type: none"> 0 ... no decimal point. 0.0 ... 1 decimal point. 0.00 ... 2 decimal points. 0.000 ... 3 decimal points
CAL1	<p>Correction of sensor. The set value is added to process value. Range: -999 to 999 °C.</p>
rL 1	<p>Together with parameter rh 1 you also set the scale of displaying measured values for process input ranges. Range: -499 to rh 1.</p>
rh 1	<p>Together with parameter rL 1 you also set the scale of displaying measured values for process input ranges. Range: rL 1 to 2499.</p>
Ftr1	<p>You set filter coefficient for input signal. The more the filter coefficient is the more the filter smoothes the input signal. Range: oFF, 0.1 to 60.0 seconds.</p>

CoMM, communication line

Display	Meaning
CoMM	<p>Setting of communication line:</p> <ul style="list-style-type: none"> Mod ... the controller is set for communication with PC. SgnL ... the controller transmits information for controlling of SLAVE units.
bAud	<p>Baudrate of communication, is in default setting - 9600Bd.</p>
Addr	<p>Address of the equipment, it is shown when CoMM = Mod.</p>

out1, output 1

Display	Meaning
ot1	<p>Function of the control output 1:</p> <ul style="list-style-type: none"> oFF ... the output 1 is turned OFF. ht ... the heating control, PID controlling. ht2 ... the heating control, ON/OFF controlling
Ct1	<p>Time cycle for switching of the output 1. Range: 1 to 200 seconds</p>
ALGo	<p>Algorithms of PID controlling:</p> <ul style="list-style-type: none"> PId ... one set of PID parameters is used. 2PId ... both sets of PID parameters are used.
SPId	<p>Limit between PID set 1 and PID set 2. Range: -499 to 2499 °C.</p>
PLLo	<p>Power limit function for the limiting of output power at low measured values, in %. Range: 0 to 100 %.</p>

SP	Setting of limit between low and high values of power limit function. Range: -499 to 2499 °C.
PLhI	Power limit function for the limiting of output power at high measured values, in %. Range: 0 to 100 %.

out2, output 2

Display	Meaning
ot2	Function of the output 2: <ul style="list-style-type: none"> oFF ... output 2 is turned OFF. CL ... cooling control, PID controlling. CL2 ... cooling control, ON/OFF controlling. SGPr ... signalling when process value is beyond the defined limits, absolute value. SGdE ... signalling when process value is beyond the defined limits, deviation from stp value SP1. rSP ... signalling when remote set stp value is absent (Master / Slave, cascade controlling).
SP2	Stp value for the output 2 (deviation from stp value of the output 1). Range: 0 to 1000 °C.
Ct2	Time cycle for switching of the output 2. Range: 1 to 200 seconds.
SI d2	The selection of active limits for alarm: <ul style="list-style-type: none"> both ... low and high limit is active. hI ... high limit is active. Lo ... low limit is active.

out3, alarm output

Display	Meaning
ot3	Function of the alarm output: <ul style="list-style-type: none"> oFF ... alarm output is turned OFF. ALPr ... alarm defined by the absolute value. ALdE ... alarm defined by the deviation from stp value SP1.
Lat3	Setting for alarm latching: <ul style="list-style-type: none"> oFF ... temporary alarm. on ... permanent alarm.
SIL3	Setting for alarm silencing at the power-up: <ul style="list-style-type: none"> oFF ... alarm function is active. on ... alarm function is deactivated.
SI d3	The selection of active limits for alarm: <ul style="list-style-type: none"> both ... low and high limit is active. hI ... high limit is active. Lo ... low limit is active.
hYS3	Hysteresis for switching for the alarm output. Range: 1 to 249 °C.

SYS, system parameters

Display	Meaning
FKEY	Function of the key „F“: <ul style="list-style-type: none"> oFF ... the key „F“ has no function. A-M ... the key „F“ is intended for switching between automatic and manual operation.
SP1L	The limit of low range for stp value. Range: -499 to SP1h °C.
SP1h	The limit of high range for stp value. Range: SP1L to 2499 °C.
rAMP	Ramp rate to stp value SP1 when in controlling to stp value. If you set oFF , ramp function is OFF. • Range: oFF , 1 to 999 °C.
rtI	Setting of time for recovery of remote stp value. Range: 1 to 99 seconds.
rErr	Response of the control output when time rtI is exceeded when in controlling Master / Slave. • oFF ... the control output is turned OFF. • SP1 ... controlling to stp value SP1.
dErt	It makes the character of derivative value more accurate. The more value is set, the more derivative value is damped down. • Range: 1.0 to 100.0 seconds.

uSER, setting of user menu

Display	Meaning
StP1	<p>Parameter that is placed on the 1st position of user menu:</p> <ul style="list-style-type: none"> • no ... no parameter • PCn1 ... indicates power in % of the control output 1. • PCn2 ... indicates power in % of the control output 2. • AoFF ... function for switching alarm OFF. • Aut ... starting / ending of autotuning of PID parameters. • L-r ... selection of setting for stp value controlling. • dIF ... difference of remote stp value for system <i>Master-Slave</i>. • CdLo ... limit of low range for remote stp value for <i>cascade controlling</i>. • CdhI ... limit of high range for remote stp value for <i>cascade controlling</i>. • Pb1A ... proportional band of the output 1, PID set 1. • It1A ... integral value of the output 1, PID set 1. • dE1A ... derivative value of the output 1, PID set 1. • Pb1b ... proportional band of the output 1, PID set 2. • It1b ... integral value of the output 1, PID set 2. • dE1b ... derivative value of the output 1, PID set 2. • hYS1 ... hysteresis of the output 1 in ON/OFF controlling. • Pb2A ... proportional band of the output 2 • It2A ... integral value of the output 2 • dE2A ... derivative value of the output 2 • hYS2 ... hysteresis of the output 2 in ON/OFF controlling. • o2Lo ... low limit of signalling for the output 2. • o2hI ... high limit of signalling of the output 2. • ALLo ... low limit of alarm. • ALhI ... high limit of alarm.
StP2	Parameter that is placed on the 2nd place of user menu. The list is the same as in StP1 .
StP3	Parameter that is placed on the 3rd place of user menu. The list is the same as in StP1 .
StP4	Parameter that is placed on the 4th place of user menu. The list is the same as in StP1 .
StP5	Parameter that is placed on the 5th place of user menu. The list is the same as in StP1 .
StP6	Parameter that is placed on the 6th place of user menu. The list is the same as in StP1 .
StP7	Parameter that is placed on the 7th place of user menu. The list is the same as in StP1 .
StP8	Parameter that is placed on the 8th place of user menu. The list is the same as in StP1 .

PASS, passwords for the entry to higher levels of menu

Display	Meaning
P oP	<p>Password for the entry to operation level. If it is set oFF, the entry is not secured with password.</p> <ul style="list-style-type: none"> • Range: oFF, 1 to 9999.
PAS Co	<p>Password for the entry to configuration level. If it is set oFF, the entry is not secured with password.</p> <ul style="list-style-type: none"> • Range: oFF, 1 to 9999.
PAS SE	<p>Password for the entry to service level. If it is set oFF, the entry is not secured with password.</p> <ul style="list-style-type: none"> • Range: oFF, 1 to 9999.

6.1 Measurement

The right selection, the installation, the wiring, the location of sensor in the equipment and the corresponding setting of parameters of the controller has the essential importance for the correct function. Parameters for the configuration of the measurement input are in *configuration level*, menu **InP1**.

Setting of input sensor

Set the corresponding input sensor in parameter **SEn1**. You will find the survey of input sensors in the chapter **Technical parameters**, see page 28.

You can set the position of decimal point by parameter **dEC1**. For thermal sensors it is possible to display without decimal point or with 1 decimal point.

Set the calibration of sensor with the parameter **CAL1**. The set value is added to process/measured value.

You can set the limit for set point value in *configuration level*, menu **SYS**, parameters **SP1L** and **SP1h**.

Important:

- Thermocouple and RTD inputs have the detection of improperly wired sensor. When the sensor is open or broken, the control output is turned OFF, the alarm output is activated.

Measuring range of process inputs

In *configuration level*, menu **InP1**, you can define the measuring range of the process inputs with parameters **rL 1**, **rh 1** and **dEC1**.

Example of setting process input:

You want the input signal 4 to 20 mA to be displayed in the range 6.0 to 24.0.

Set **dEC1** = 0.0, **rL 1** = 6.0 a **rh 1** = 24.0. The distribution between the values 6.0 and 24.0 will be linear.

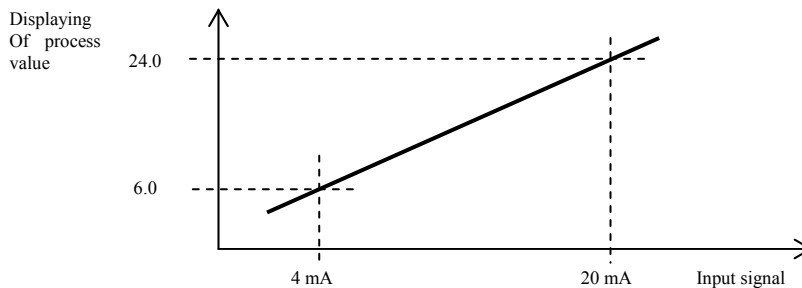

6.2 Controlling, the control output

You can select in the controller ON/OFF or PID controlling for heating. If PID controlling is set, you can use the autotuning of PID parameters, see page 9 and the power limit function, see page 17.

The parameters for configuration of the control output 1 are in *configuration level*, menu **out1**.

ON/OFF controlling

ON/OFF control is selected by setting **ot1** = **ht2**. It is used for less exacting application. It is not possible to achieve zero hysteresis value on principle. The process value rises and drops about set point value in the characteristic way.

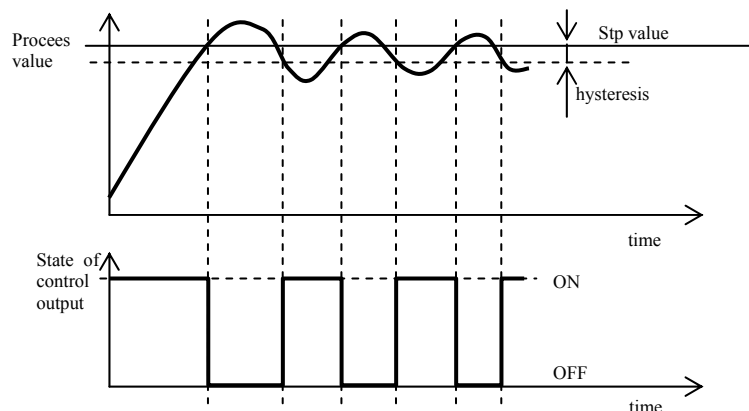

PID controlling

PID control is selected by setting `ot1` = `ht`. It provides the precise control. For the correct function of the controller, however, it is necessary to set properly PID parameters. Autotuning for setting of PID parameters is described on page 9. PID parameters have the following meaning:

- **Pb proportional band** is set in measured units. It is the band about the set point value in which the controller keeps the temperature.
- **It integral factor**, in minutes. Integral factor compensates the loss of system. A **low** integral value causes a **fast** integrating action.
- **de derivative factor**, in minutes. Derivative responds to fast changes and tries to react against them. The **more** value is, the **more** derivative factor reacts.

If the control output is 2 state (ON/OFF) (relay or SSR), the power is (given in %) transferred to the output with so called pulse width modulation. In each time cycle (parameter `ct1`, you will find it in *configuration level*, menu `out1`) the control output is switched ON once and once OFF. The more the power is necessary, the wider the width of switching is. The output responses are illustrated in the third part of the drawing.

Example of pulse width modulation of the output:

- Time cycle is 10 seconds, the power requested is 30%. The output is ON for 3 seconds and OFF for 7 seconds.
- Time cycle is 10 seconds, the power requested is 5%. The output is ON for 0,5 second and OFF for 9,5 seconds.

Important:

- The duration of time cycle has the influence on the quality of control. The longer the cycle is, the less the quality of control is.
- If the electromechanical unit (relay, switching contactor) is used for the control output, the duration of time cycle must be set longer with regard to lifetime of switch.

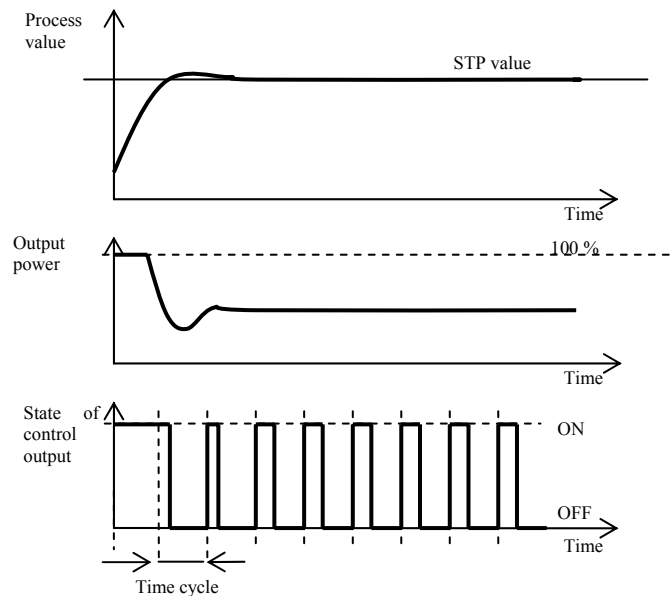

Power limit function

You can improve the quality of control by limiting of the output power.

Example how to use the power limit function:

When rising at set point value the big overshoot occurs. One of possible solution is the power limit in the vicinity of set point value. The procedure is the following:

- Find out the power supplied to the stable system.
- Set the switcher `S PL` on the value by several °C less than set point value.
- Set power limit `PLLo` to 100%.
- Set power limit `PLhI` approx. by 10 to 20% higher than the power supplied to the stable system.

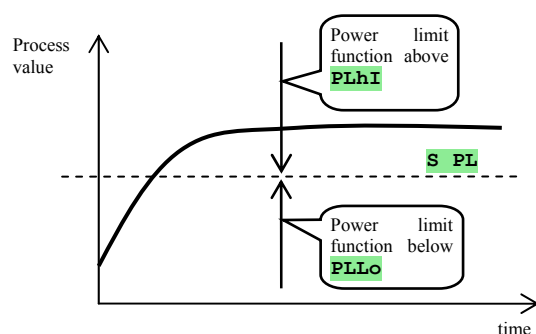

6.3 Alarm

The third output (output 3) is alarm.

The configuration parameters of the output you will find in *configuration level*, menu **out3**, setting of the alarm limits **ALLo** and **ALhI** you will find in *operation level or user level*.

Setting of alarm output

Set this function with parameter **out3**:

- **ot3** = **OFF**, alarm output is turned OFF.
- **ot3** = **ALPr**, alarm limits defined by the absolute value.
- **ot3** = **ALdE**, alarm limits are set as the deviation from stp value SP1.

Important:

- Relay in standby MODE means **active alarm**.
- When controller is switched OFF, error of sensor, error of controller the alarm is active.

Alarm defined by the absolute value of temperature **ot3** = **ALPr**

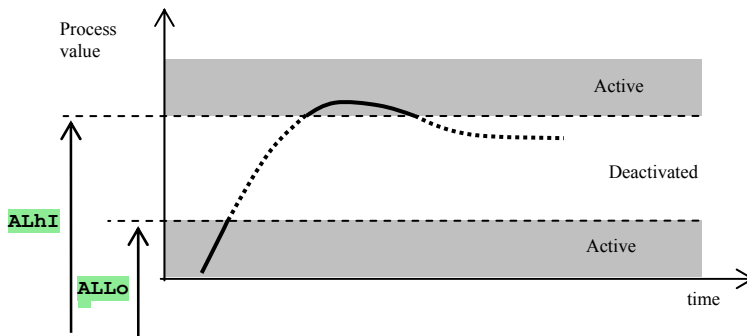

Alarm limits are defined from absolute values.

Alarm defined by the deviation from stp value **ot3** = **ALdE**

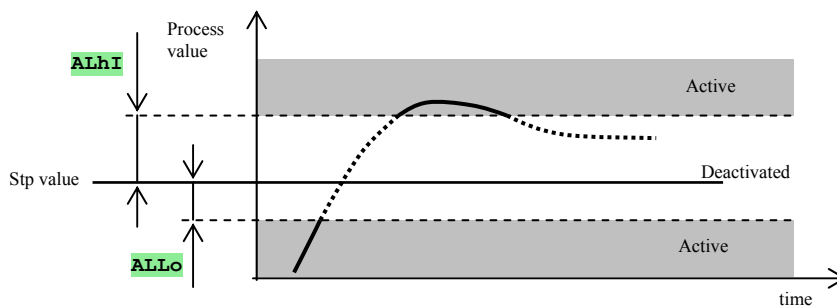

Parameters **ALLo** and **ALhI** define low and high deviation from stp value at which alarm is active.

Temporary, permanent(latched) alarm

Alarm can be temporary (**LAAt3** = **OFF**) or permanent (**LAAt3** = **on**).

- Temporary alarm will turn automatically off when the alarm condition is over.
- Permanent alarm is turned ON even when the alarm condition is over. Turn OFF permanent (latched) alarm when the alarm condition is over by the function **AoFF**, that is found in *user level* or *operation level*. Permanent alarm is also turned off after the supply voltage interruption.

Silencing of alarm

Silencing of alarm can be used to disable alarm at startup rising to set point value. This state should not be evaluated as error because the system is not yet stable. This function is set with the parameter:

- **SIL3** = **oFF**, function is not active
- **SIL3** = **on**, alarm can be activated after the process value at startup rising reached the allowed range for the first time (between alarm limits).

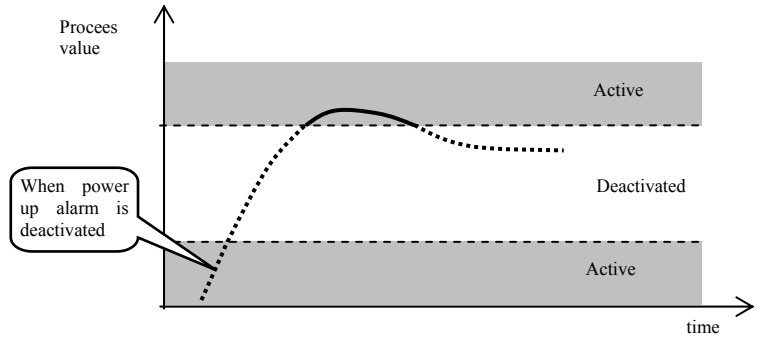

Active sides of alarm

With parameter **sid3** you can choose the active side of alarm:

- **sid3** = **both**, both sides (limits) are active.
- **sid3** = **hI**, only high alarm side (limit) is active.
- **sid3** = **Lo**, only low alarm side (limit) is active.

6.4 System Master – Slave

If the controller is equipped with communication line (EIA-485), it can be set up as MASTER as well as SLAVE in system *Master – Slave*, ie. in system when 1 controller transmits stp value and the other controllers receive this stp value. Slave controllers can modify this value by difference, parameter **dIF**.

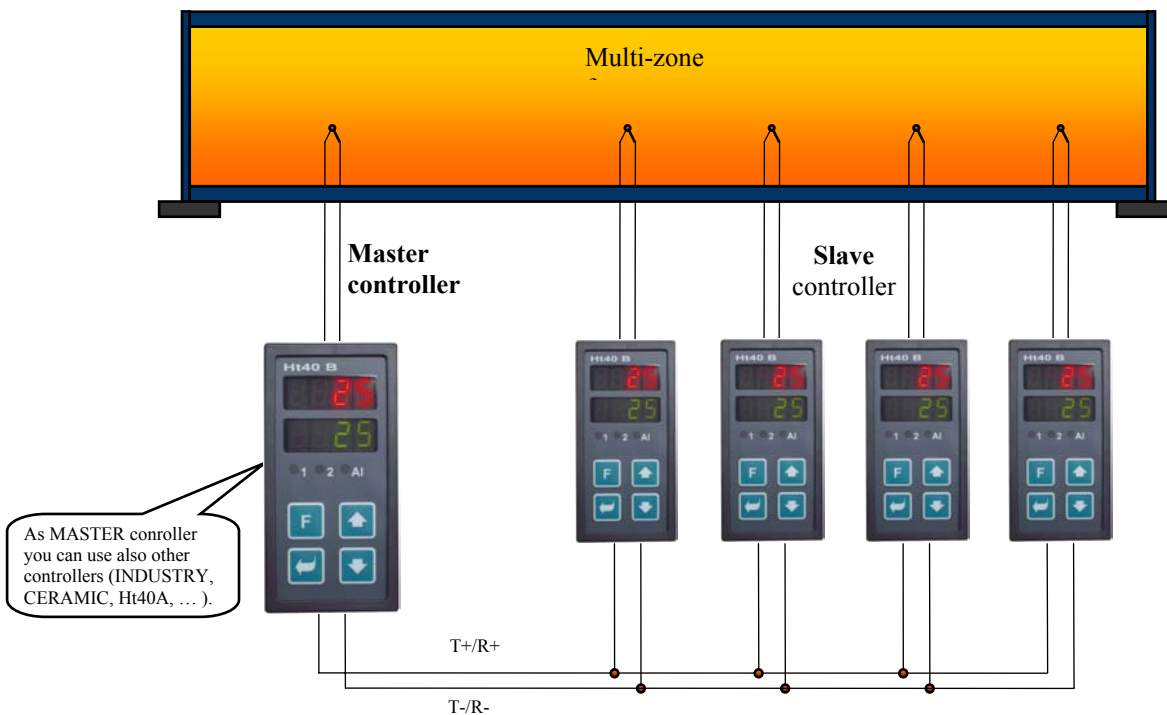

Setting of the controller – Master

- In *configuration level*, menu **CoMM**, set parameter **CoMM** = **SGnL**.
- In *operation level*, parameter is set **L-r** = **L**.

Setting of the controller - Slave

- In *configuration level*, menu **CoMM**, set parameter **CoMM** = **Mod**, setting of the parameters **Addr** can remain unchanged.
- In *operation level*, set parameter **L-r** = **M-S**.
- The response to communication error in the reception of stp value you can set in *configuration level*, menu **sys**, parameters **rtI** and **rErr**.
- The communication error in the reception of stp value can be indicated with the output 2, by setting **ot2** = **rSP**. If the controller does not receive stp value from communication line, the output 2 will be switched ON.

6.5 Cascade controlling

Cascade controlling is used for system with long lag times, i.e. in systems where the response to the turn ON of action unit is too (e.g. in muffle furnace, ..). By configuration of 2 controllers as a cascade system you achieve that long lag time will be divided into 2 parts and thus you improve the quality of control.

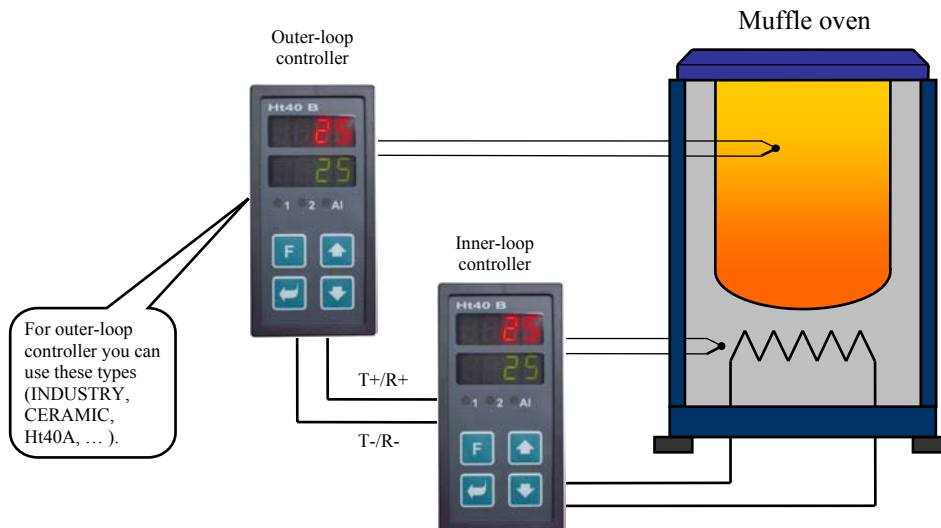

Setting of outer-loop controller

- In *configuration level*, menu **CoMM**, set parameter **CoMM** = **SGnL**.
- In *operation level* you have to set parameter **L-r** = **L**.

Setting of inner-loop controller

- In *configuration level*, menu **CoMM**, set parameter **CoMM** = **Mod**, setting of parameter **Addr** can remain unchanged.
- In *operation level* set parameter **L-r** = **CSCd**.
- In *operation level* set with the parameters **CdLo** a **CdhI** the temperature range in which the inner-loop controller will control.
- Error in communication connection of controllers you can indicate with output 2, set **ot2** = **rSP**. If the controller does not receive the information from communication line, the output 2 will be switched ON.

7 Service level

Service level is intended for service workers. In this level **the control output is switched OFF and alarm and signal output is deactivated.**

To get from basic mode to service level press the keys **↓ ↑** for about 3 seconds. On lower display **LEVL** appears, on upper one set **SErV** and confirm. If **PASS** appears on lower display, level is secured with password. In this case set the correct password with arrow-keys and confirm again.

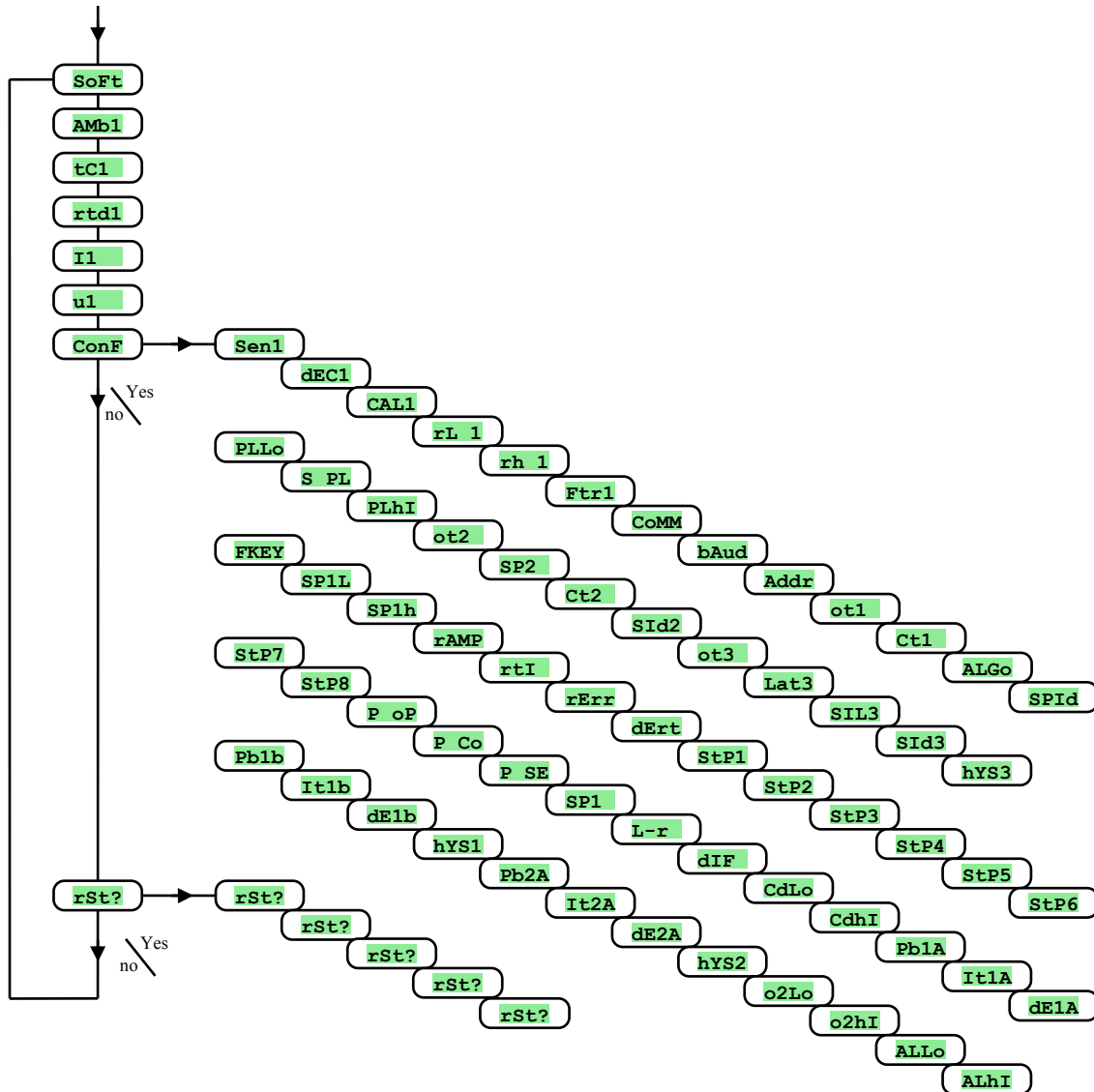

Display	Meaning
SoFt	Number of software version.
AMb1	Actual ambient temperature.
tC1	Measured voltage, thermocouple input 1. Range 60mV.
rtd1	Measured resistance, rtd input 1. Range 350 ohms.
I1	Measured current, current input 1. Range 20mA.
u1	Measured voltage, voltage 1. Range 10V.
ConF	By setting YES and confirming you enter the menu for setting all the parameters. This menu can be used e. g. in initial setting of the controller.
rSt?	Editing of initial parameters is the significant action to controller's setting. First it must be confirmed by 6x setting YES.
rSt?	
rSt?	
rSt?	
rSt?	
rSt?	

8 Table of parameters

Table of parameters for configuration level:

Sen1	
dEC1	
CAL1	
rL 1	
rh 1	
Ftr1	
CoMM	
bAud	
Addr	
ot1	
Ct1	
ALGo	
SPid	
PLLo	
S PL	
PLhI	
ot2	
SP2	
Ct2	
SiD2	
ot3	
Lat3	
SIL3	
SiD3	
hYS3	
FKEY	
SPIL	
SPlh	
rAMP	
rtI	
rErr	
dErt	
StP1	
StP2	
StP3	
StP4	
StP5	
StP6	
StP7	
StP8	
P oP	
P Co	
P SE	

Table of parameters for operation level:

L-r	
dIF	
CdLo	
CdhI	
Pb1A	
It1A	
dE1A	
Pb1b	
It1b	
dE1b	
hYS1	
Pb2A	
It2A	
dE2A	
hYS2	
o2Lo	
o2hI	
ALLo	
ALhI	

9 Installation

The controller is designed to be mounted to the panel cutout. Slide the controller into the cutout and fix it with 2 flanges that are supplied with the controller. The installation requires the access to the back of the panel.

Mounting dimensions

- Width x height x overall length: 48 x 96 x 121 mm (including terminal board).
- Behind panel length: 114 mm ((including terminal board).
- Cutout in the panel: 44 x 91 mm.
- The thickness of panel: 1,5 to 10 mm.

Mounting

- Make the panel cutout 44 x 91 mm.
- Slide the controller into the panel cutout.
- Insert the flanges for holding into the holes upward and downward or on both sides of the controller.
- Tighten the screws firmly on the flanges.

The controller is now installed, before wiring we recommend to read thoroughly the chapter on the possible sources of interference and principals for installation.

Wiring of the controller begins on page [24](#).

9.1 Principals for installation, the sources of interference

There are many possible sources of interference in environment of the controller. Among the most harmful sources of interference are the following:

- Equipment with inductive load, e.g. electromotors, winding of relays and breakers,
- Thyristors and other semiconductor equipment
- Welding devices.
- Wires carrying high currents.
- Fluorescent lightings and neon lights.

9.2 Reduction of influence of interference

Making a design of system, try to observe these guidelines:

- All wires of power supply voltage and power wires carrying high currents must be lead separately from signal leads (e.g. thermocouple lead wire, communication lines). Minimum distance between these types of wires should not be smaller than 30 cm.
- If signal and power wires cross each other it is suitable for them to be crossed in right angle.
- From the beginning try to find the possible sources of interference and keep the wires away from them.
- Do not install relays and breakers very close to the controller.
- Do not use supply voltage for the controller also for supplying inductive and phase angle control equipment.
- Twisted and shielded wires should be used for signal leads. Shielding should be earthed several times.

When necessary the uninterruptible power sources (UPS) could be used.

10 Wiring

To avoid potential electric shock, use safety practices laid down by national standards when wiring and connecting this unit to a power source. Failure to do so could result in such damage, and / or injury. The wiring must be done only by the authorized person.

If there is any default of the device could cause damage, the equipment with the controller must be fitted with the independent protection unit (thermal cut-out).

Supply voltage

Before you connect the unit to a supply power source, check the level of supply voltage. The controller is intended for use in industrial or in laboratory equipment.

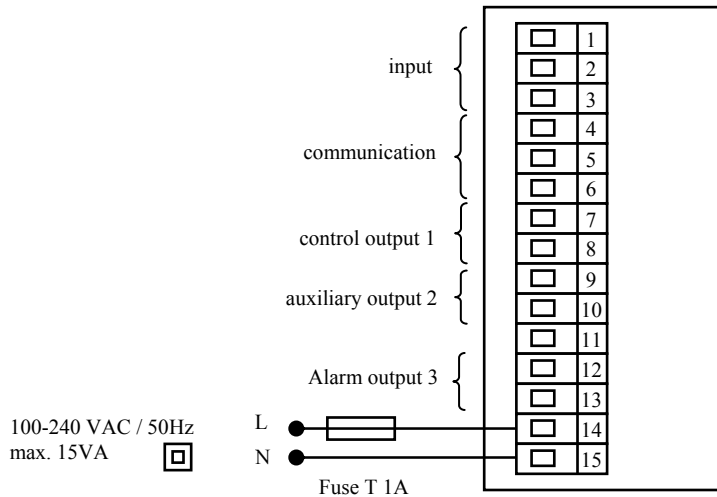

measuring input (InP1)

Thermal input

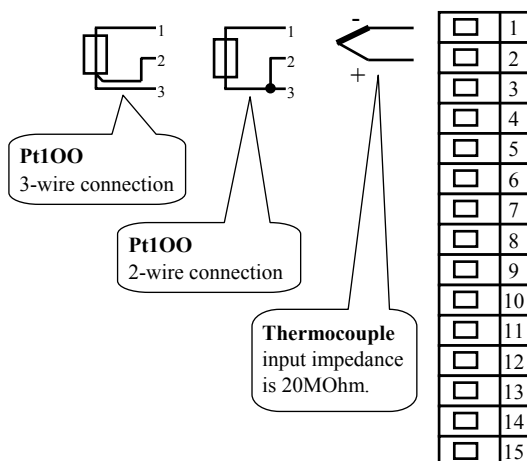

Process input

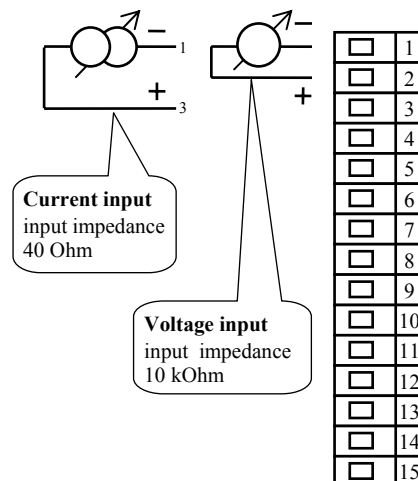

Measuring input is not isolated from the ground of controller

communication line (CoMM)

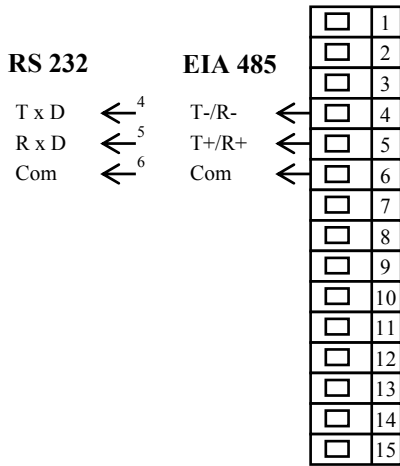

Communication is galvanically isolated from the ground

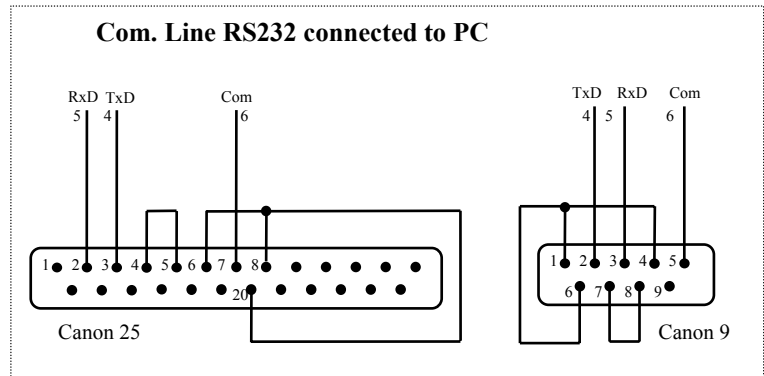

control output 1 (out1)

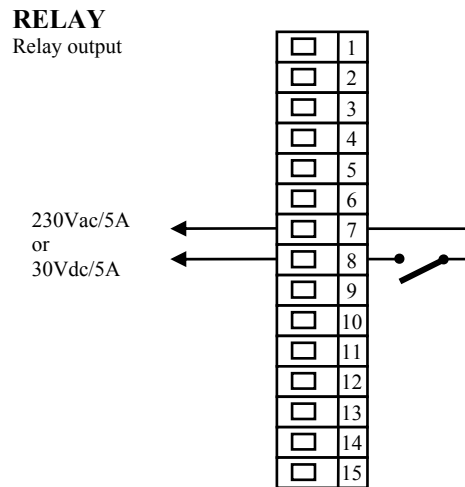
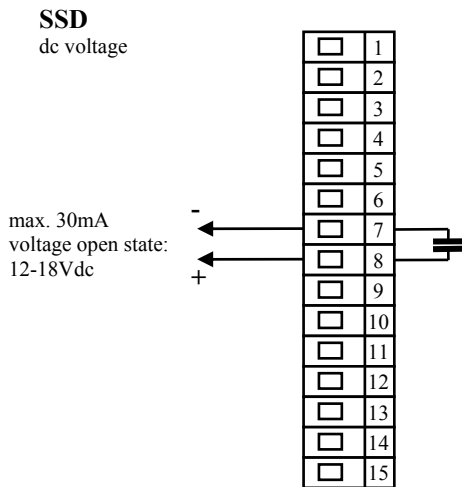

SSD is not isolated from controllers ground

RELAY output is galvanically isolated from the ground of the controller. For this output it is necessary to fix the wires in the way that in case of loosening the wire from the terminal the insulation would not be reduced between supply voltage and safety voltage.

auxiliary output 2 (out2)

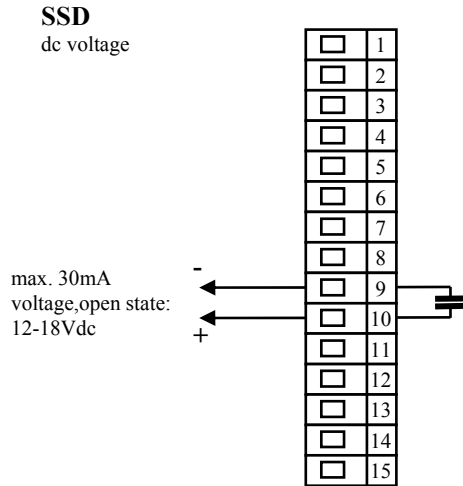

**SSD is not isolated
from controllers
ground**

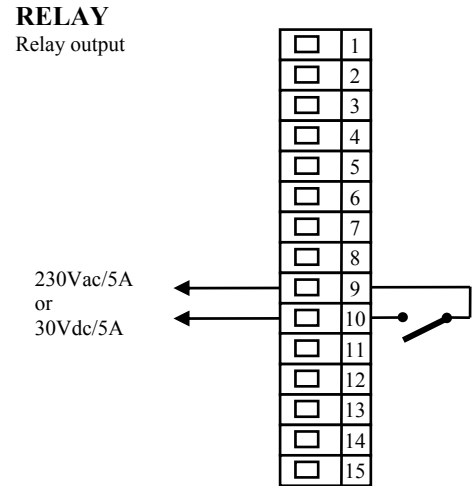

RELAY output is galvanically isolated from the ground of the controller. For this output it is necessary to fix the wires in the way that in case of loosening the wire from the terminal the insulation would not be reduced between supply voltage and safety voltage.

Alarm output

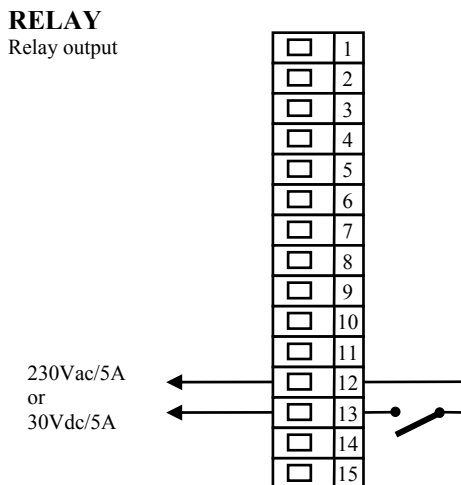

RELAY output is galvanically isolated from the ground of the controller. For this output it is necessary to fix the wires in the way that in case of loosening the wire from the terminal the insulation would not be reduced between supply voltage and safety voltage.

11 Putting into operation

The initial set-up can be done only by the qualified and authorized person. The wrong set-up can cause serious damage. When you power the controller up for the first time, you must enter the most necessary data to the controller for its problem-free operation:

- Type of sensor, position of decimal point
- Operational range of set point value
- Set-up for the control output

11.1 Guidelines

Let's suppose that the controller is installed in the panel and you have just power it up for the first time. Parameters of initial operation are the following:

- **SEn1**, set input sensor. The descriptions of this parameter see on page [13](#).
- **dEC1**, set the position of decimal point. You will find the description of this parameter on page [16](#). This parameter is shown only for the process input.
- **rL 1**, **rh 1**, parameters for setting of the scale of displaying values for process inputs. These are not displayed for thermal inputs. The description of parameters is on page [16](#).
- **ot1**, setting of the control output. The descriptions of this parameter see on page [13](#).
- **SP1L**, set low limit of range of stp value. We recommend to leave 0.
- **SP1h**, set high limit of range of stp value. We recommend to set maximum working temperature of equipment. The operator can not set higher stp value than this value of parameter.
- Further information about input setting you will find on page [16](#), information about output setting on page [16](#).

Important:

- All the parameters that were set in the initial operation can be later changed in *configuration level*.

12 Technical parameters

The controller is intended for use in industrial or laboratory equipment, the category of pollution / over voltage II.

Controlling

- PID, PI, PD, P controlling, autotuning/automatic setting of PID parameters, controlling of heating or cooling.
- ON/OFF controlling, controlling of heating or cooling.

Alarm

- absolute alarm, high limit of alarm.

Controlling of stp value

- controlling of stp value,
- controlling Master / Slave,
- cascade controlling.

Indicators and keys

- two 4-figure LED displays, segment height 10 mm,
- 3 LED indicating diodes of outputs,
- 4 keys, setting is done via menu

Sensors, inputs

Thermal input is thermocouple or rtd, the detection of bad-wired/broken sensor :

- **no** ... no input is set,
- **J** ... thermocouple J, range -200 to 900°C,
- **K** ... thermocouple K, range -200 to 1360°C,
- **t** ... thermocouple T, range -200 to 400°C,
- **n** ... thermocouple N, range -200 to 1300°C,
- **E** ... thermocouple E, range -200 to 700°C,
- **r** ... thermocouple R, range 0 to 1760°C,
- **s** ... thermocouple S, range 0 to 1760°C,
- **b** ... thermocouple B, range 300 to 1820°C,
- **c** ... thermocouple C, range 0 to 2320°C,
- **d** ... thermocouple D, range 0 to 2320°C,
- **rtd** ... sensor rtd (Pt100), range -200 to 800°C, 2 or 3-wire connection, DIN curves.

Process input - current (input impedance 40 Ω), voltage (10 k Ω), without the detection of broken sensor:

- **no** ... no input is set,
- **0-20** ... 0 – 20 mA, range -499 to 2499 units,
- **4-20** ... 4 – 20 mA, range -499 to 2499 units,
- **0-5** ... 0 – 5 V, range -499 to 2499 units,
- **1-5** ... 1 – 5 V, range -499 to 2499 units,
- **0-10** ... 0 – 10 V, range -499 to 2499 units.

Output 1

- ss driver/open collector, 12 – 18 V dc in the state ON, max. 30 mA.
- Electromechanical relay, 230Vac/5A or 30Vdc/5A, switching ON, without RC suppression unit.

Output 2

- ss driver/open collector, 12 – 18 V dc in the state ON, max. 30 mA.
- Electromechanical relay, 230Vac/5A or 30Vdc/5A, switching ON, without RC suppression unit.

Output 3

- Electromechanical relay, 230Vac/5A or 30Vdc/5A, switching ON, without RC suppression unit.

Communication line

- RS 232, galvanically isolated, protocol Modbus RTU,
- EIA 485, galvanically isolated, protocol Modbus RTU.

Accuracy of inputs

- $\pm 0,1\%$ of span/range (min. 540°C) , ± 1 digit at $25^{\circ}\text{C} \pm 3^{\circ}\text{C}$ of ambient temperature and at $\pm 10\%$ rated supply voltage
- temperature stability $\pm 0,1^{\circ}\text{C}/^{\circ}\text{C}$ in ambient
- voltage stability $\pm 0,01\%/%$ of change in supply voltage

Supply voltage

- 100 to 240 VAC 50 Hz, internal slow fuse 2 A/250 V
- input power max. 15 VA
- data stored in memory upon power failure

Operating environment

- 0 to 50°C
- 0 to 90 % relative humidity, non-condensing

Shipping and storage

- -20 to 70°C

Dimensions

- width x height x length 48 x 96 x 121 mm,
- depth behind panel surface 114 mm,
- cutout into the panel 44 x 91 mm, , the thickness of the panel 1,5 to 10 mm.

12.1 Warranty

The supplier provides 36-month warranty on defects in material and workmanship on this controller with the exception on defects caused by mechanical or electrical wearing out of the outputs. This warranty does not also apply to damage resulting from inappropriate transportation and storage, misuse, wrong wiring, ambient influences (especially effects of electrical overvoltage, electrical values and temperatures of inadmissible intensity, chemical materials, mechanical damage) electrical or mechanical overloading of inputs and outputs.

12.2 Description of model

Ht40B – a b – c d e – f g h

- **a: input**
T = thermal input
P = process input
- **b: communication line**
0 = none
X = communication line RS 232
A = communication line EIA 485
- **c: output 1 (control)**
K = ss driver
R = electromechanical relay
P = current 0-20 mA, 4-20 mA
N = voltage 0-5 V, 0-10 V
- **d: output 2 (auxiliary)**
0 = none
K = ss driver
R = electromechanical relay
P = current 0-20 mA, 4-20 mA
N = voltage 0-5 V, 0-10 V
- **e: alarm output**
R = electromechanical relay
- **f, g, h: 0 0 0**

13 Index

1	Important.....	2
2	Basic terms	3
2.1	Operation and description of controller.....	3
2.2	Information and error messages	3
2.3	Overview of levels, menus	4
3	Basic mode.....	5
4	User level.....	6
4.1	Controlling of stp value	7
4.2	Automatic / manual operation of controller	8
4.3	Parameters of the control output, PID controlling	8
4.4	Autotuning – automatic setting of PID parameters	9
5	Operation level.....	10
6	Configuration level.....	12
6.1	Measurement.....	16
6.2	Controlling, the control output	16
6.3	Alarm	18
6.4	System Master – Slave	19
6.5	Cascade controlling	20
7	Service level	21
8	Table of parameters.....	22
9	Installation.....	23
9.1	Principals for installation, the sources of interference	23
9.2	Reduction of influence of interference	23
10	Wiring.....	24
11	Putting into operation.....	27
11.1	Guidelines	27
12	Technical parameters	28
12.1	Warranty	29
12.2	Description of model	29
13	Index	30